



# HOW TO ASSEMBLE

## CURTAIN & NETTING SET FOR 10'-12' / 3-3.6m GAZEBOS

Compatible with Palram - Canopia's  
Palermo™ 10x10 / 3x3 | 11x11 / 3.5x3.5 | 12x12 / 3.6x3.6  
Milano™ 10x10 / 3x3  
Martinique™ 10x12 / 3x3.6

### IMPORTANT!

Please read these instructions carefully before starting assembly.  
Keep these instructions in a safe place for future reference.

[www.canopia.com](http://www.canopia.com)



A member of  
Palram Industries Ltd.



Curtain Set



Netting Set



# 1

## PARTS REQUEST

**In the case of missing or damaged parts, do not return product to store.**

Go to the link below or scan the QR code for help, it will direct you to a form that will help us assist you as soon as possible.



SCAN ME

Contact us on our website:  
[bit.ly/3js7yZi](https://bit.ly/3js7yZi)

# 2

## ASSEMBLY ASSISTANCE

If you need any technical assistance in assembling your product, go to the link below or scan the QR code for help. It will direct you to a form that will help us assist you as soon as possible.



SCAN ME

Contact us on our website:  
[bit.ly/3kqqFEc](https://bit.ly/3kqqFEc)



## CUSTOMER SUPPORT



SCAN ME

# WE ARE HERE TO HELP

For general questions: [bit.ly/3kY07dP](https://bit.ly/3kY07dP)

### USA



877-627-8476



[hobbyservice@poly-tex.com](mailto:hobbyservice@poly-tex.com)

### CANADA



905-5646007



[sales@footprintproducts.com](mailto:sales@footprintproducts.com)

### UNITED KINGDOM · IRELAND



01302-380775



[customer.serviceUK@palram.com](mailto:customer.serviceUK@palram.com)

### GERMANY



0180-522-8778



[customer.serviceDE@palram.com](mailto:customer.serviceDE@palram.com)

### FRANCE · BELGIUM



+33-169-791-094



[customer.serviceFR@palram.com](mailto:customer.serviceFR@palram.com)

### ISRAEL



04-848-6816



[info.il@palram.co.il](mailto:info.il@palram.co.il)

### ITALY · NETHERLANDS · PORTUGAL · SPAIN



+33-169-791-094



[customer.serviceFR@palram.com](mailto:customer.serviceFR@palram.com)

### AUSTRIA · LUXEMBURG · LIECHTENSTEIN



+49-180-522-8778



[customer.serviceDE@palram.com](mailto:customer.serviceDE@palram.com)

### AUSTRALIA



03-9219-4444



[salesvic@palram.com](mailto:salesvic@palram.com)

NORWAY · SWEDEN · ARGENTINA · GREECE · GREENLAND · ICELAND · ESTONIA · JAPAN · LATVIA · LITHUANIA

MAURITIUS · MEXICO · ROMANIA · RUSSIA · TURKEY · UZBEKISTAN · UKRAINE · SWAZILAND · KOREA



+972-4-848-6816



[customer.service@palram.com](mailto:customer.service@palram.com)



## CUSTOMER SUPPORT



SCAN ME

# WE ARE HERE TO HELP

For general questions: [bit.ly/3kY07dP](https://bit.ly/3kY07dP)

### AUSTRALIA - GREENHOUSES

 03-9544-6-999

 [info@mazedistribution.com.au](mailto:info@mazedistribution.com.au)

### HUNGARY · SLOVAKIA

 +420-493-523-523

 [servis@garland.cz](mailto:servis@garland.cz)

### NEW ZEALAND

 0800 800 880

 [customer.service@palram.com](mailto:customer.service@palram.com)

### DENMARK

 07-575 42 70

 [post@nshnordic.com](mailto:post@nshnordic.com)

### SOUTH AFRICA

 011-397-7771

 [receptionza@palram.com](mailto:receptionza@palram.com)

### CROATIA · SLOVENIA

 0599-37-057

 [info@ms-viscom.com](mailto:info@ms-viscom.com)

### CZECH REPUBLIC

 0493-523-523

 [servis@garland.cz](mailto:servis@garland.cz)

### FINLAND

 Neuvonta: 09-6866720  
Tuki / Varaosat: 050-3715350

 [www.horisontenterprises.fi](http://www.horisontenterprises.fi)  
[tuki@horisontenterprises.fi](mailto:tuki@horisontenterprises.fi)

### POLAND

 Infolinia: 801-011-929  
22-349-93-36

 [kontakt@ogrodosfera.pl](mailto:kontakt@ogrodosfera.pl)

### CYPRUS

 0224-971-13

 [alpaco@alpacodomica.com](mailto:alpaco@alpacodomica.com)  
[www.alpacodomica.com](http://www.alpacodomica.com)

### SWITZERLAND

 062-287-33-77

 [info@ritter.ch](mailto:info@ritter.ch)



## DIGITAL INSTRUCTIONS WORLDWIDE

ES

Para reducir las cantidades de papel utilizadas, los manuales de instrucciones preliminares fueron traducidos a muchos otros idiomas y están disponibles en nuestro sitio web [www.canopia.com](http://www.canopia.com).

Los encontrará en la página web respectiva de(los) producto(s) CANOPIA que haya elegido, así como a las **instrucciones de seguridad, las indicaciones para preparar el terreno, cómo colocar los cimientos** y mucho más...

HE

על מנת לצמצם שימוש בכמויות נייר, תרגמנו את ההוראות המקדימות בשפות רבות נוספות, אותן תוכלו למצוא באתר האינטרנט שלנו [www.canopia.com](http://www.canopia.com). תוכלו למצוא אותן בדף האינטרנט של המוצר CANOPIA שבחרתם, כולל **הוראות בטיחות, הנחיות להכנת השטח לפני הרכבה, הקמת בסיס מוצר ועוד...**

NL

Om de hoeveelheid gebruikt papier te verminderen, hebben we de voorlopige instructies vertaald naar meerdere extra talen en ze beschikbaar gemaakt voor u op onze website [www.canopia.com](http://www.canopia.com).

U kunt deze vinden op de respectieve webpagina van het (de) CANOPIA product(en) dat (die) u hebt gekozen, **inclusief veiligheidsinstructies, richtlijnen om uw site voor te bereiden, uw fundering** te leggen en meer...

IT

Per ridurre la quantità di carta utilizzata, abbiamo tradotto le istruzioni preliminari in molte altre lingue e le abbiamo messe a vostra disposizione sul nostro sito web [www.canopia.com](http://www.canopia.com).

Potete trovare queste istruzioni sulla pagina web del prodotto CANOPIA di vostra scelta, **comprese le istruzioni di sicurezza, le istruzioni per la preparazione del terreno, la posa delle fondamenta** e molto altro...

SV

För att minska mängden papper som använts har vi översatt de preliminära instruktionerna på många andra språk och gjort dem tillgängliga för dig på vår webbplats [www.canopia.com](http://www.canopia.com).

Du hittar dem på respektive webbsida för CANOPIA-produkterna du har valt, inklusive **säkerhetsinstruktioner**, anvisningar för att **förbereda din plats, skapa din grund** och mycket annat ...

NN

For å redusere mengden papir som brukes har vi oversatt de preliminære instruksene i mange ekstra språk og gjort dem tilgjengelig for deg på nettsiden vår [www.canopia.com](http://www.canopia.com).

Du finner dem på den respektive nettsiden til CANOPIA produkt(ene) du har valgt, **inkludert sikkerhetsinstruksjoner, instruksjoner for å forberede området, legge fundamentet** og mer...

FI

Paperin määrän vähentämiseksi olemme kääntäneet alustavat ohjeet monille muille kielille ja saattaneet ne saataville verkkosivustollamme [www.canopia.com](http://www.canopia.com).

Löydät ne kunkin CANOPIA-tuotteen vastaavalta verkkosivulta, mukaan lukien **turvallisuusohjeet, ohjeet asennuspaikan valmistelemiseksi, perustan luomiseksi** ja paljon muuta...

DA

For at reducere mængden af brugt papir har vi oversat de foreløbige instruktioner til mange andre sprog og har gjort dem tilgængelige for dig på vores hjemmeside [www.canopia.com](http://www.canopia.com).

Du finder dem på den respektive CANEBSITE for de CANOPIA-produkter, du har valgt, **herunder sikkerhedsinstruktioner, anvisninger til forberedelse af dit siteebsted, indstilling af dit fundament** og mere...



## DIGITAL INSTRUCTIONS WORLDWIDE

SL

Da bi zmanjšali količino porabljenega papirja, smo predhodna navodila prevedli v številne dodatne jezike in vam jih dali na voljo na naši spletni strani [www.canopia.com](http://www.canopia.com).

Našli jih boste na ustrezni spletni strani izdelka(-ov) CANOPIA, ki ste ga(jih) izbrali, vključno z **varnostnimi navodili**, navodili za **pripravo gradbišča**, **postavitve temeljev** in še več...

CS

Abychom snížili množství použitého papíru, přeložili jsme předběžné pokyny do mnoha dalších jazyků a zpřístupnili jsme je na našich webových stránkách [www.canopia.com](http://www.canopia.com).

Najdete je na příslušné webové stránce produktů CANOPIA, které jste si vybrali, **včetně bezpečnostních pokynů, pokynů k přípravě pozice, nastavení základů** a další...

HU

A felhasználókat papírmennyiség csökkentése érdekében az előkészületi utasításokat szívesebben nyelvre lefordítottuk, és a [www.canopia.com](http://www.canopia.com) weboldalunkon elérhetővé tettük az Ön számára.

Ezeket a kívánt CANOPIA termék(ek) megfelelő weboldalán találja meg, **beleértve a biztonsági utasításokat, a helyszín előkészítésére, az alapozásra vonatkozó utasításokat és még sok más...**

LT

Lai samazinātu izmantotā papīra daudzumu, esam iztulkojuši sākotnējās instrukcijas daudzās papildu valodās un padarījušas tās pieejamas mūsu vietnē [www.canopia.com](http://www.canopia.com).

Jūs tulkojumus atradīsiet attiecīgajā izvēlētā(-o) CANOPIA produkta(-u) tīmekļa lapā, tur atradīsiet arī **drošības instrukcijas, norādījumus, kā sagatavot vietni, iestatīt pamatu un vēl vairāk...**

SK

Za účelom zníženia množstva použitého papiera sme preložili predbežné pokyny do mnohých ďalších jazykov a sprístupnili sme ich pre vás na našej webovej stránke [www.canopia.com](http://www.canopia.com).

Nájdete ich na príslušnej webovej stránke produktov CANOPIA, ktoré ste si vybrali, **vrátane bezpečnostných pokynov, pokynov na prípravu vášho pracoviska, vytvorenia základov** a ďalších...

ET

Kasutatava paberi koguse vähendamiseks oleme tõlkinud esialgsed juhised paljudesse lisakeeltesse, need on teile kättesaadavad meie veebilehel [www.canopia.com](http://www.canopia.com).

Leiate need teie poolt valitud CANOPIA toote (toodete) **vasataval veebileheküljel, sealhulgas ohutusjuhised, teie objekti ettevalmistuse, aluse seadmise juhised** ja palju muud...

PL

W celu zmniejszenia ilości zużywanego papieru przetłumaczyliśmy wstępną instrukcję w wielu dodatkowych językach i udostępniliśmy ją Państwu na naszej stronie internetowej [www.canopia.com](http://www.canopia.com).

Znajdziecie je Państwo na stronie internetowej wybranego produktu CANOPIA, łącznie z **instrukcjami bezpieczeństwa, wskazówkami dotyczącymi przygotowania terenu, fundamentów** i wieloma dodatkowymi informacjami..

RU

Чтобы сократить количество используемой бумаги, мы перевели предварительные инструкции на множество других языков и сделали их доступными для вас на нашем веб-сайте [www.canopia.com](http://www.canopia.com).

Вы найдете их на соответствующей веб-странице изделия CANOPIA, которые вы выбрали, **включая инструкции по безопасности, инструкции по подготовке вашего места, закладке основы** и многое другое...

## SAFETY ADVICE

- Dispose of all plastic bags safely – keep them away from children’s reach.
- Keep children away from the assembly area.
- When using a stepladder or power tools, make sure that you are following the manufacturer’s safety advice.

## IMPORTANT RECOMMENDATIONS

- These instructions are compatible with Palram Canopia’s  
Palermo 10x10 / 3x3 | 11x11 / 3.5x3.5 | 12x12 / 3.6x3.6  
Milano 10x10 / 3x3  
Martinique 10x12 / 3x3.6
- Please carry out the steps in the order set out in these instructions.
- Keep these instructions in a safe place for future reference.



## IMPORTANT ASSEMBLY STEPS

**When encountering this information icon during assembly, please refer to the relevant assembly step for important additional comments.**

In order to assemble the curtain / netting you will need to use part #7829.

This part is supplied with the gazebo. If the part was not inserted while the gazebo was assembled please refer back to the Palermo / Milano / Martinique Garden Gazebo Assembly Instructions.

(You can download the assembly instructions from our website: [www.canopia.com](http://www.canopia.com))

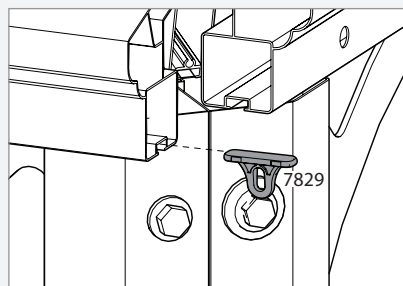

## BEFORE ASSEMBLY

1. This curtain / netting set includes 4 parts that cover the entire gazebo.
2. Please read these instructions carefully before you start to assemble this product.
3. Some of the steps may require the assistance of a second person.

## TOOLS & EQUIPMENT



□ Ladder



□ Wrench 10 mm | 13/32”

### Step 3:

(Palermo 10x10 / 3x3 | Milano 10x10 / 3x3) Adjust the curtain / netting to the appropriate size.

### Step 4:

(Martinique 10x12 / 3x3.6) Adjust the curtain / netting to the appropriate size.

- When closed, the curtain / netting has to be stretched in order to properly maintain them.
- When opened, the curtain / netting should be tied to the poles with the built-in straps.

### \*Optional:

It is possible to thread a curtain weight chain at the bottom.

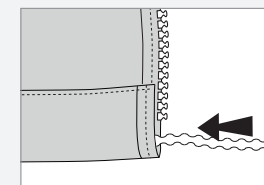

## CONSEILS DE SECURITE

- Jetez précautionneusement tous les sacs plastiques – tenez-les hors de portée des enfants.
- Tenez les enfants à distance de la zone de montage.
- Si vous utilisez un escabeau ou des outils électriques, assurez-vous de respecter les consignes de sécurité du fabricant.

## RECOMMANDATIONS IMPORTANTES

- Ces instructions ne sont compatibles qu'avec le Gazebo du jardin Palram Canopia's Palermo 10x10 / 3x3 | 11x11 / 3.5x3.5 | 12x12 / 3.6x3.6  
Milano 10x10 / 3x3  
Martinique 10x12 / 3x3.6
- Veuillez suivre les étapes dans l'ordre indiqué dans ces instructions.
- Conservez ces instructions en lieu sûr pour référence ultérieure.



## PRINCIPALES ÉTAPES D'ASSEMBLAGE

**Lorsque vous rencontrez cette icône d'information pendant l'assemblage, veuillez vous référer à l'étape d'assemblage correspondante pour d'autres commentaires importants.**

Pour assembler le rideaux / filet, vous aurez besoin d'utiliser la partie **#7829**. Cette partie est fournie avec le gazebo. Si la partie n'a pas été insérée alors que le gazebo a été assemblé, veuillez vous référer aux instructions d'assemblage du Palermo / Milano / Martinique Jardin Gazebo. (Vous pouvez télécharger les instructions de montage sur notre site Web : [www.canopia.com](http://www.canopia.com))

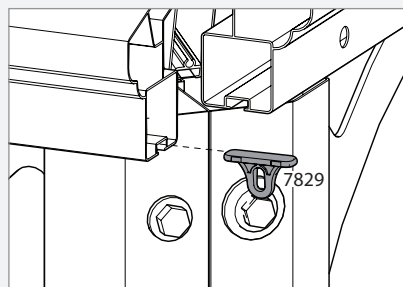

## AVANT LE MONTAGE

1. Cet ensemble de rideaux / filets est composé de 4 parties et couvre la totalité du gazebo.
2. Veuillez lire attentivement ces instructions avant de commencer l'assemblage de ce produit.
3. Certaines étapes nécessitent l'aide d'une deuxième personne.

## OUTILS ET ÉQUIPEMENT

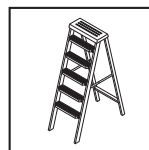

□ Echelle



□ Pincès

### Étape 3:

(Palermo 10x10 / 3x3 | Milano 10x10 / 3x3) Ajuster les rideaux / filets à la taille appropriée

### Étape 4:

(Martinique 10x12 / 3x3.6) Ajuster les rideaux / filets à la taille appropriée

- Veuillez garder les rideaux / filets tendu si vous souhaitez les fermer.
- Une fois que vous aurez ouvert les rideaux / filets, vous devez les attacher aux cannes avec les sangles intégrées.

#### \* Facultatif:

il est toutefois possible d'enfiler une série de poids du rideau à la partie inférieure.

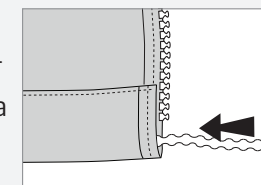



## SICHERHEITSHINWEISE

- Entsorgen Sie die Plastikbeutel vorschriftsgemäss – und achten Sie darauf, dass sie nicht in Reichweite von Kindern kommen.
- Halten Sie Kinder während des Aufbaus vom Carport fern.
- Wenn Sie eine Stufenleiter oder Elektrowerkzeuge benutzen, achten Sie darauf, die Sicherheitshinweise des Herstellers zu befolgen.

## WICHTIGE HINWEISE

- Diese Anweisungen sind nur gültig für Palram Canopia's Palermo 10x10 / 3x3 | 11x11 / 3.5x3.5 | 12x12 / 3.6x3.6  
Milano 10x10 / 3x3  
Martinique 10x12 / 3x3.6
- Bitte führen Sie die einzelnen Schritte in der in dieser Anleitung angegebenen Reihenfolge durch.
- Bewahren Sie diese Anleitung für späteren Gebrauch sicher auf.



## WICHTIGE MONTAGESCHRITTE

**Wenn Sie bei der Montage auf dieses Informationssymbol stoßen, finden Sie im jeweiligen Montageschritt wichtige Zusatzhinweise.**

Um den Vorhang oder die Netzgarnitur anzubringen, müssen Sie Teil #7829 benutzen. Dieses Teil wird mit der Gartenlaube selbst mitgeliefert. Wenn dieses Teil nicht während der Pavillon-Konstruktion eingefügt wurde, schauen Sie in der Konstruktionsanleitung des Palermo / Milano / Martinique Garden Gazebo nach.  
(Sie können diese auch von der Webseite herunterladen: [www.canopia.com](http://www.canopia.com))

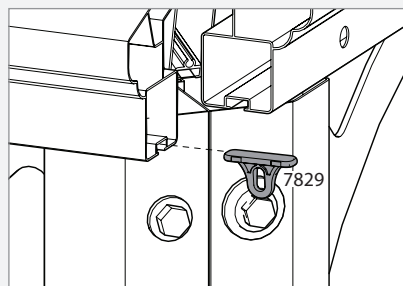

## VOR DEM ZUSAMMENBAU

1. Diese Vorhänge/Umnetzung bzw. Netzgarnitur enthält 4 Teile, die den gesamten Gartenlaube bedecken.
2. Um den Pavillon vollständig zu bedecken, müssen Sie eine weitere Garnitur kaufen.
3. Einige der Arbeitsgänge machen es notwendig, dass eine zweite Person zur Hand geht

## WERKZEUGE & AUSRÜSTUNG

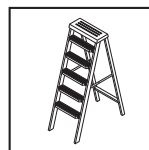

☐ Leiter



☐ Zange

### Schritt 3:

(Palermo 10x10 / 3x3 | Milano 10x10 / 3x3) Gardinen / Netze auf die geeignete Größe einstellen.

### Schritt 4:

(Martinique 10x12 / 3x3.6) Gardinen / Netze auf die geeignete Größe einstellen.

- Wenn Sie die Vorhänge/Umnetzung schliessen, müssen diese straff sitzen, damit sie besser erhalten bleiben.
- Wenn Sie die Vorhänge/Umnetzung öffnen, sollten Sie diese an den Stangen mit den angebrachten Schlaufen festmachen.

#### \*Optional:

Es ist möglich, unten eine Gewichtskette für Vorhänge einzufädeln.

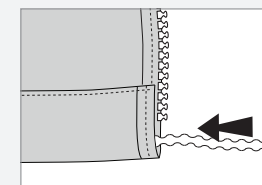

2

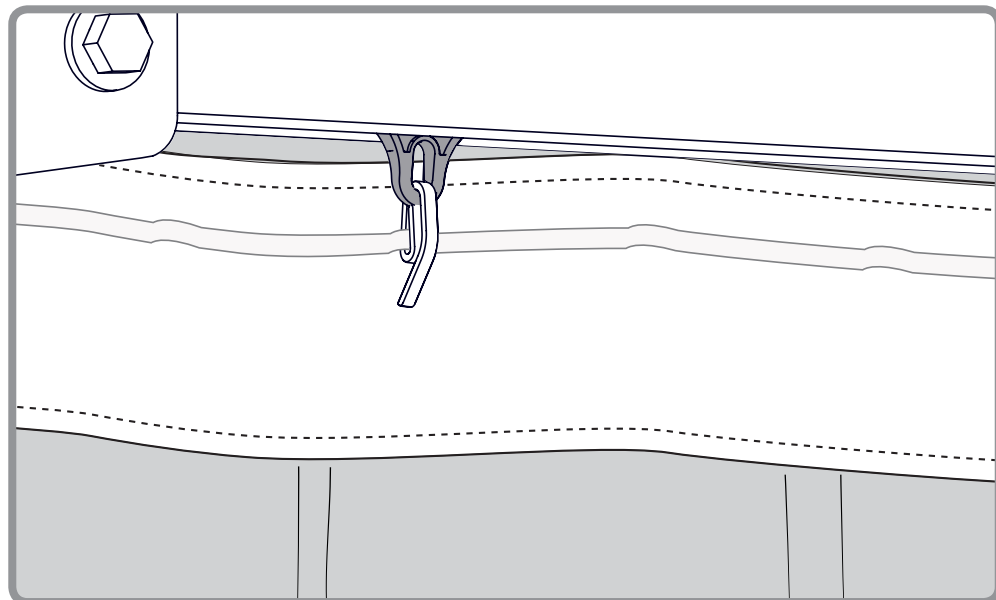
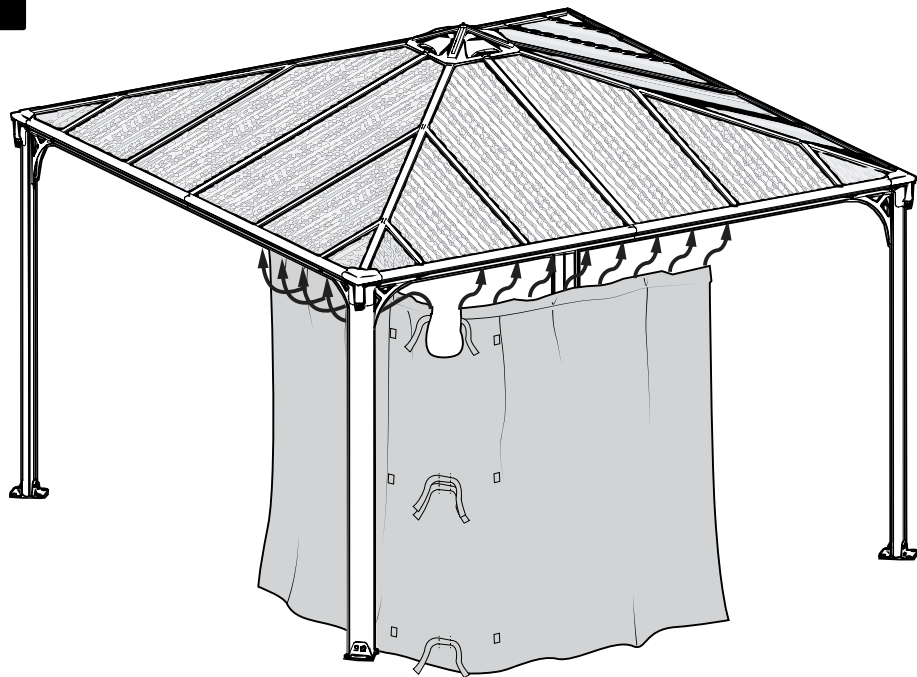

3

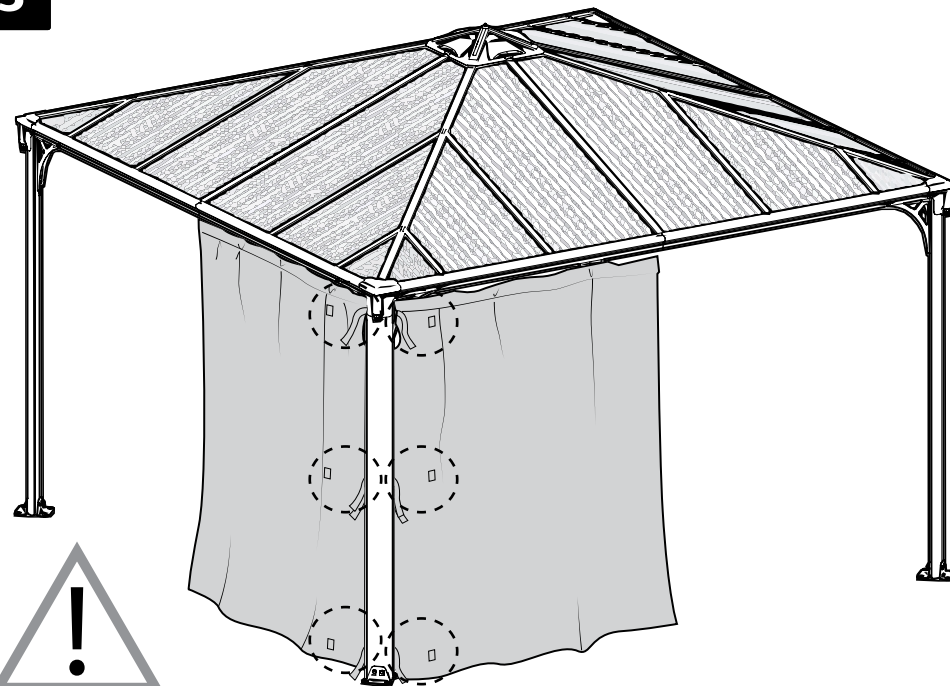

Milano 3000  
Palermo 3000

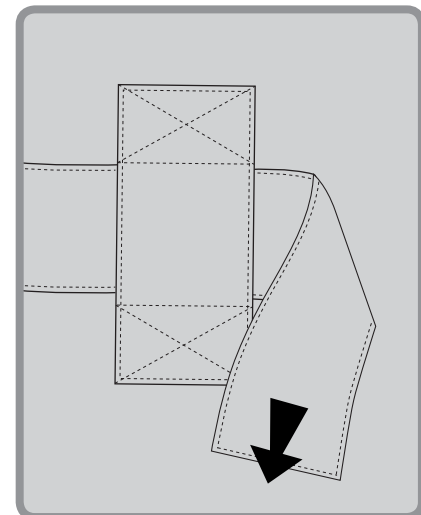
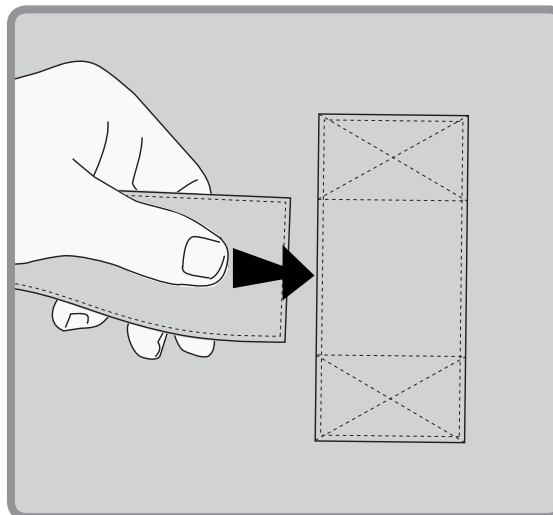

4

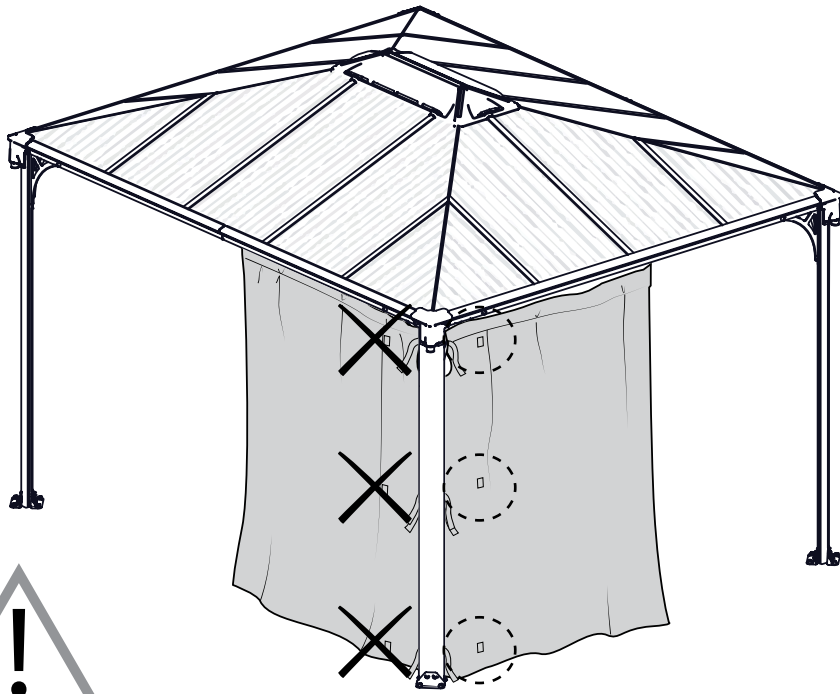

Martinique 3600

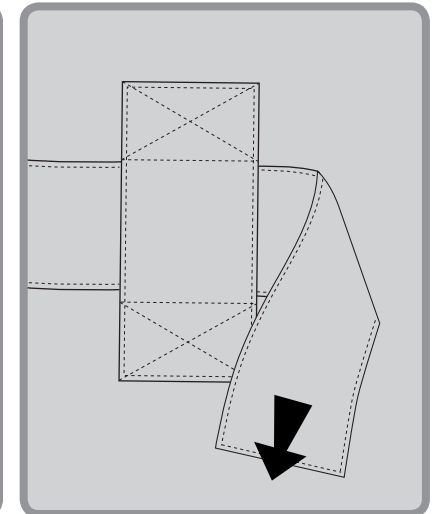
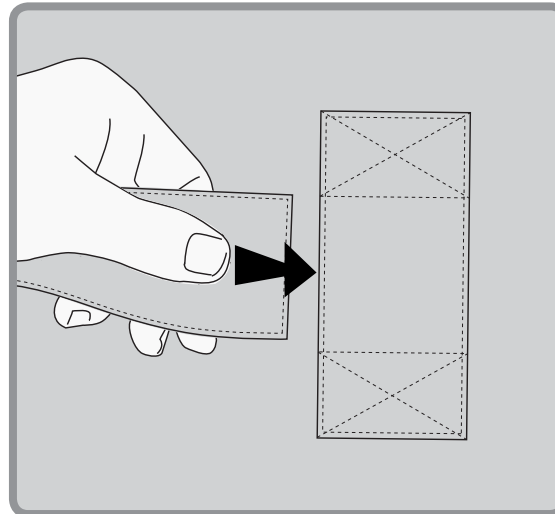

5

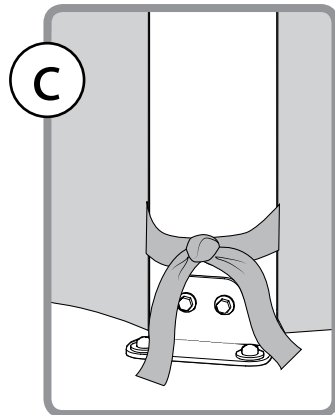
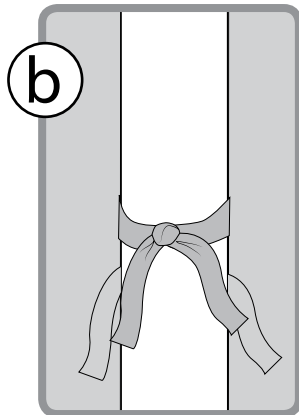
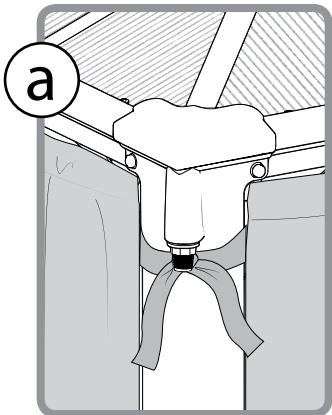
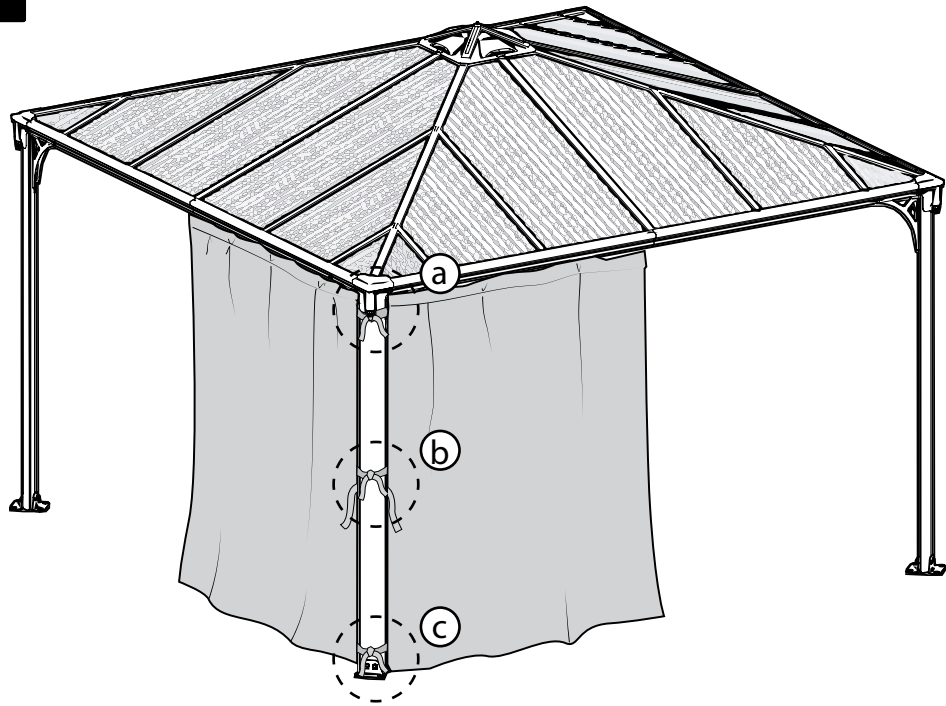

6

